

KEITHLEY

Model 870 Digital Thermometer Instruction Manual

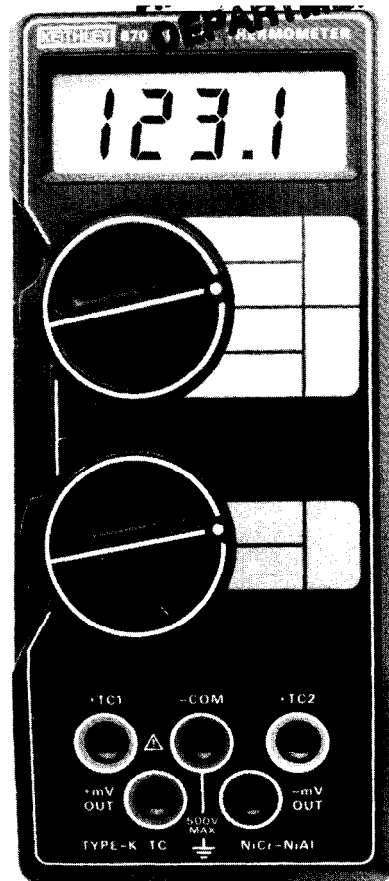

Specifications

RANGES

TEMPERATURE SENSOR: Type K (NiCr-NiAl) thermocouple
THERMOCOUPLE INPUTS: Two, switch selected.

RANGES	TEMPERATURE SPAN	RESOLUTION
200°F	-40.0 to 199.9	0.1°F
2000°F	-40 to 1999	1°F
200°C	-40.0 to 199.9	0.1°C
1370°C	-40 to 1370	1°C

ACCURACY: $\pm(0.25\%$ of reading + 1°C) for one year, $18^\circ\text{--}28^\circ\text{C}$ ambient. Includes NBS conformity, cold junction reference, and repeatability errors. Excludes thermocouple errors; however, thermocouple errors around 0°C may be compensated for by internal zero adjustment.

REPEATABILITY: $\pm 0.2^\circ\text{C}$ typical (1 hour, constant ambient temperature).

TEMPERATURE COEFFICIENT ($0^\circ\text{--}18^\circ\text{C}$ & $28^\circ\text{--}50^\circ\text{C}$): Less than $(0.1 \times$ accuracy specification) $^\circ\text{C}$.

INPUT CURRENT: 200nA maximum.

MAXIMUM ALLOWABLE INPUT: 150V continuous, 300V momentary (10 seconds).

NORMAL MODE REJECTION RATIO: Greater than 45dB at 50 & 60Hz.

COMMON MODE REJECTION RATIO (1k Ω unbalance): Greater than 120dB at DC, 50 & 60Hz.

GENERAL

DISPLAY: $3\frac{1}{2}$ -digit LCD, 0.6" height. Polarity and decimal point indication.

CONVERSION PERIOD: 400ms.

OVERRANGE & OPEN-THERMOCOUPLE INDICATION: Display blanked except for overrange digit.

MAXIMUM COMMON MODE VOLTAGE: 500V.

mV OUTPUT: Non-linearized, cold-junction compensated thermocouple output.

mV OUTPUT ACCURACY ($18^\circ\text{--}28^\circ\text{C}$): $\pm 40\mu\text{V}$ ($^\circ\text{C}$ ranges); $\pm 80\mu\text{V}$ ($^\circ\text{F}$ ranges).

mV OUTPUT TEMPERATURE COEFFICIENT ($0^\circ\text{--}18^\circ\text{C}$ & $28^\circ\text{--}50^\circ\text{C}$): Less than $(0.1 \times$ accuracy specification) $^\circ\text{C}$.

mV OUTPUT PROTECTION: 35V maximum.

ENVIRONMENTAL LIMITS: Operating: $0^\circ\text{--}50^\circ\text{C}$, less than 80% relative humidity up to 35°C , less than 70% relative humidity from $35^\circ\text{--}50^\circ\text{C}$. Storage: -35°C to 60°C .

COLD-JUNCTION COMPENSATION: Semiconductor temperature sensor.

THERMOCOUPLE LINEARIZATION: Multi-slope A/D with 11 piecewise-linear segments between -40°C and 1370°C .

INPUT CONNECTIONS: Banana jacks (3).

mV OUTPUT CONNECTION: Dual banana jack.

POWER: 9V alkaline or carbon-zinc (NEDA 1604) battery.

BATTERY LIFE, CONTINUOUS: 100 hours typical with alkaline battery; 50 hours typical with carbon-zinc battery.

BATTERY INDICATOR: Display indicates "BAT" when less than 10% of life remains.

DIMENSIONS, WEIGHT: 178mm long \times 78mm wide \times 38mm thick (7.0" \times 3.1" \times 1.5"). Net weight 300gm (10.6 oz.).

ACCESSORIES SUPPLIED: Battery, manual, Model 8702 Thermocouple Sensor.

Initial Preparation

The Model 870 comes equipped ready for use with a battery and a K-type TC sensor (Model 8702). Descriptions of other available probes and accessories can be found in the Accessories Section of this manual.

WARNING

Turn the 870 off and disconnect the input probes before replacing the battery. Put the cover back into place on the battery compartment before resuming use of the instrument.

Battery Installation/Replacement

A 9V battery is supplied with the instrument but not installed. To install or replace the battery, remove the cover from the battery compartment by sliding it off in the direction of the arrow located on the battery cover. The battery connector snaps on and off the terminals of the battery. Improper installation of the battery will cause the connecting wires to be severed by excess strain. Proper installation requires that the battery be positioned in such a manner (see drawing) that the leads protruding from the boot of the battery connector face toward the out-side of the battery compartment. If the instrument is going to be stored for a long period of time or in a high temperature environment, remove the battery to prevent leakage damage.

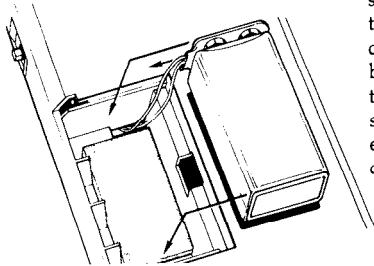

SAFETY SYMBOLS AND TERMS

The symbol  on the instrument denotes that the user should refer to the operating instructions.

The symbol  on the instrument denotes that up to 500V may be present on the terminal(s). The WARNING used in this manual explains dangers that could result in personal injury or death.

The CAUTION used in this manual explains hazards that could damage the instrument.

OPERATION NOTES

CAUTION

Do not connect both input channels when a common-mode voltage difference exists between TC probes. Otherwise, a current will circulate through the common leads of the external thermocouples, possibly causing measurement errors. Also, damage could result to the probes and external equipment. When a common-mode voltage difference exists, at least one of the probes should be electrically insulated from exposed voltage.

Note

Analog output source resistance is $17k\Omega$. External load resistance of $\geq 10M\Omega$ keeps loading error $\leq 0.17\%$ of reading.

Servicing Information

Verification Procedure

FUNCTIONALITY CHECK:

While holding the tip of a clean TC probe between your thumb and index finger, a reading ascending to between 25° and 40° C should be realized to confirm the functionality of the 870.

ACCURACY CHECK:

- .Prepare a pure-water ice bath as explained in the Calibration procedure (Setup, Step 6).
- .Connect a TC probe to Input Channel 1 of the 870.
- .Immerse the TC probe into the pure-water ice bath and allow 10 minutes for thermal stabilization.
- .Turn on the 870 and use the following table to verify that the readings on each range are within specification.

Range	Allowable Reading
2000°F	$32^\circ \pm 2^\circ$
200°F	$32.0^\circ \pm 1.8^\circ$
1370°C	$0^\circ \pm 1^\circ$
200°C	$0.0^\circ \pm 1.0^\circ$

Calibration

EQUIPMENT NEEDED:

1. DC Voltage Calibrator with $\pm 0.01\%$ of setting $\pm 20\mu V$ accuracy (Fluke 341A or equivalent)
2. 100:1 divider - $10k\Omega$ and 100Ω resistors, .02%, Wirewound
3. Pure-water ice bath - (Dewer Flask or 1 quart thermos)
4. K-type TC wire, and copper wire pair

ENVIRONMENTAL CONDITIONS: Ambient temperature of $23^\circ \pm 1^\circ C$; relative humidity less than 80%.

SETUP: (Refer to Figure 1)

1. Turn on the voltage calibrator.
2. Connect an appropriate length of K-type TC wire to input No. 1 of the 870.
 - A. Chromel (yellow insulation) to +TC1 input jack
 - B. Alumel (red insulation) to -COM input jack
3. Splice copper wires to the TC wires. Crimp lugs can be used for making the splice.

Calibration (Cont.)

4. Connect the other ends of the copper wires to the 100:1 divider as shown in Figure 1. Connect the copper/chromel wire to the positive side.
5. Connect the 100:1 divider to the DC voltage calibrator as shown.
6. Prepare the pure water ice bath as follows:
 - A. Drill a hole in the cap of the Dewar Flask to accommodate the thermocouples.
 - B. Firmly pack the flask with pea-sized ice chips made from distilled water, and then fill the flask with distilled water.
 - C. Replace the melted ice with more ice, while removing the excess water.
 - D. Replace the cap on the flask. Immerse the thermocouples into the flask and allow 20 minutes for thermal stabilization of the ice bath.

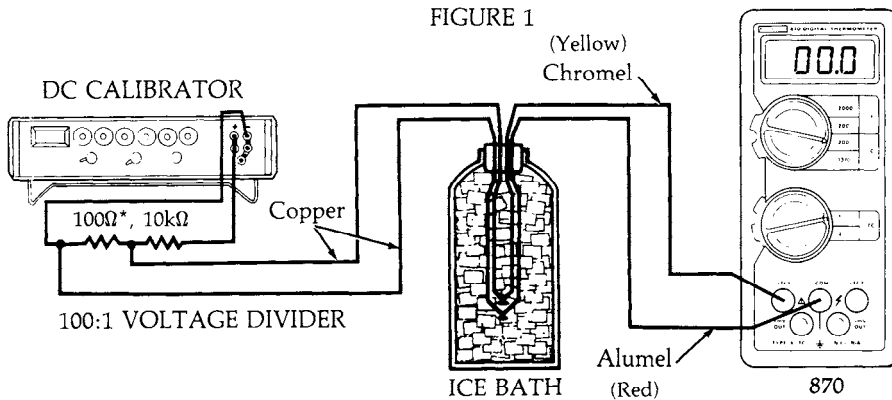

*The 100Ω resistor must be held at a uniform temperature during calibration.

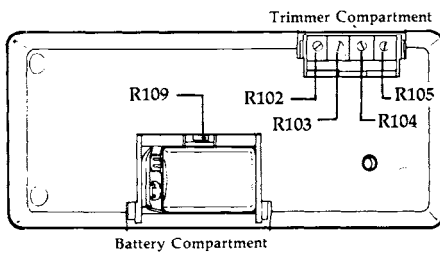

CALIBRATION PROCEDURE:

1. Remove the battery and trimmer compartment covers from the 870.
2. Turn the 870 on and perform the calibration adjustments listed in the following table.

CALIBRATION ADJUSTMENTS

Step	Adjustment	870 Range	Calibrator Setting (V)	Trimmer Adjust	Desired Reading
1	Input Offset Null	200°C	0.0000	R109	00.0
2	+ Gain(X1)	1370°C	5.3093	R104	1320
3	+ Gain (X10)	200°C	0.6939	R105	170.0
4	-Gain	200°C	-0.1527	R103	-40.0
5	°F Offset	200°F	0.0000	R102	32.0

PROBE MATCHING

To improve the accuracy of the 870 while using a particular probe, the calibration of the 870 can be adjusted so that probe errors in the region of zero (0°C) are compensated. Place the probe in an ice bath, and allow the reading to stabilize. Then reset the zero adjustment (R109) for a 0.0°C reading.

Troubleshooting Guide

The following troubleshooting information is intended to be used by qualified electronic maintenance personnel who are familiar with the proper use of standard electronic test equipment.

To gain access to the PC-board refer to the first three paragraphs of the Disassembly Instructions. Utilize the Parts List, Schematic and Component Layout for identifying parts and checking point locations. The following checks should be made with the 870 set to the 200°C range.

DC Voltage Checks:

1. Battery: $V_{BAT} > 7V$
2. Power Supplies:
 $V +$ to \downarrow (Analog Common) = $+2.8 \pm 0.4V$
 $V +$ to \downarrow (Digital Common) = $+5 \pm 1V$
3. Reference Diode: CR101 to \downarrow = $-1.23 \pm 0.03V$
4. Negative Reference Divider: (Referenced to \downarrow)

R119

Pin	mV*	Pin	mV*	Pin	mV*
2	-210	5	-204	8	-195
3	-209	6	-199	9	-186
4	-204	7	-198	10	-173

*The setting of R104 and the tolerances of the resistors within the network (R119) can affect these levels by $\pm 5\%$.

5. Deintegrate Comparators:
 U103A, Pin 3 to \downarrow = $150 \pm 25mV$
 U103B, Pin 6 to \downarrow = $-150 \pm 25mV$
6. Cold Junction Voltage:
 (Ambient temperature $25^\circ \pm 3^\circ C$)
 - COM to \downarrow = $1.0 \pm 0.6mV$

Waveform Checks: (Referenced To \downarrow)

Clock	U111, Pin 3	360kHz, 5V pp	Square Wave
A/D Clock	U112, Pin 5	40kHz, 5V pp	Rectangular Wave
Ref. Clock 1	U102, Pin 9	60kHz, 5V pp	Rectangular Wave
Ref. Clock 2	U102, Pin 14	6kHz, 5V pp	Rectangular Wave
Backplane	U101, Pin 20	50Hz, 5V pp	Rectangular Wave

Component Layout

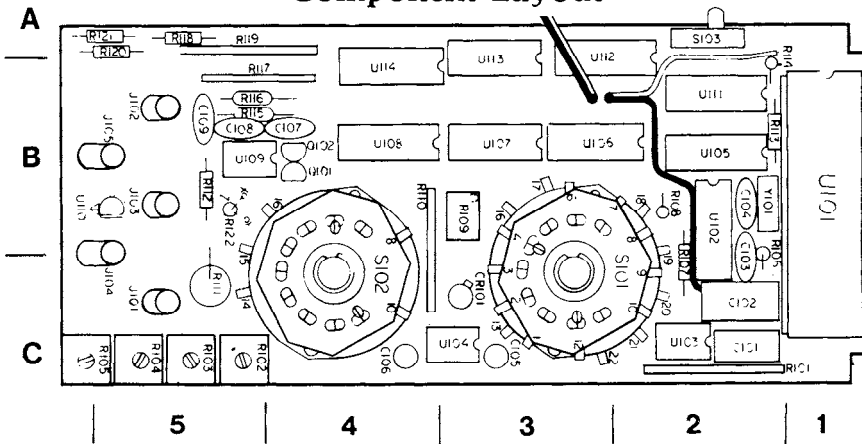

Schematic

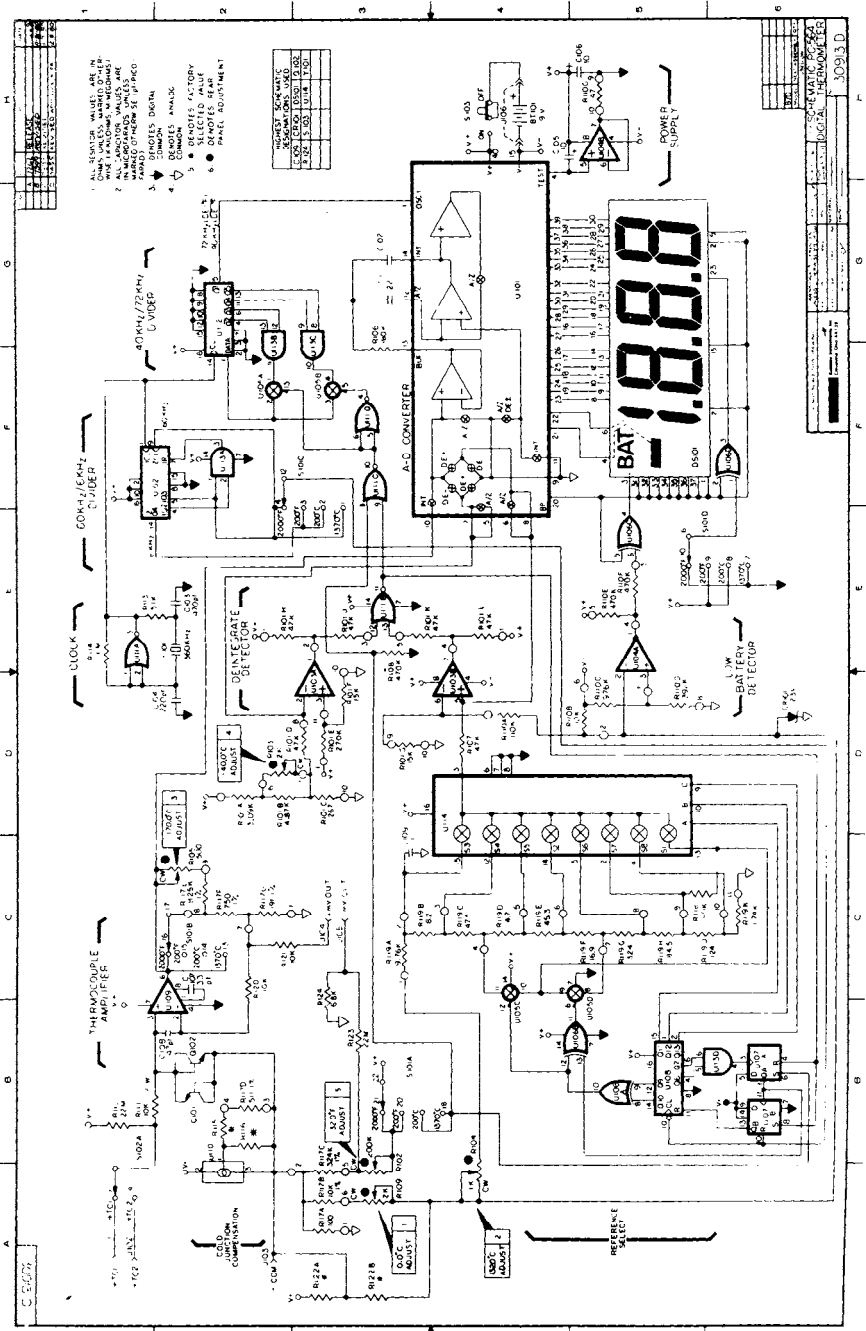

3093.D

Parts List

Circuit Desig.	Description	Schematic Location	PC-Board Location	Keithley Part No.
BT101	Battery, 9V, NEDA 1604	H4		BA-14
C101	Cap, .22 μ F, 100V, Polyester	G3	C2	C-305-.22
C102	Cap, .1 μ F, 160V, Polypropylene	G3	C2	C-306-.1
C103	Cap, 470pF, 1000V, Ceramic Disc	I2	C2	C-64-470p
C104	Cap, 220pF, 1000V, Ceramic Disc	D1,D2	B2	C-64-220p
C105	Cap, 10 μ F, 16V, Aluminum Electrolytic	H4	C3	C-321-10
C106	Cap, 10 μ F, 16V, Aluminum Electrolytic	H5	C4	C-321-10
C107	Cap, 33pF, 1000V, Ceramic Disc	C2	B4	C-64-33p
C108	Cap, 47pF, 1000V, Ceramic Disc	B2	B5	C-64-47p
C109	Cap, .1 μ F, 16V, Ceramic	C3	B5	C-238-.1
CR101	Diode, Low Voltage Reference	D6	C3	DZ-62
DS101	Liquid Crystal Display, 3½ digit	F5		DD-27
J101-105	Jack, Input	Several	Several	30300A-3
J106	Connector, Battery	H4		BH-29
Q101	Transistor, NPN, Switch, 2N3904	B2	B4	TG-47
Q102	Transistor, NPN, Switch, 2N3904	B2	B4	TG-47
R101	Thick Film Resistor Network	Several	C1	TF-120
R102	Pot, 200K Ω	A3	C5	RP-97-200K
R103	Pot, 2k Ω	D2	C5	RP-97-2K
R104	Pot, 1k Ω	B4	C5	RP-97-1K
R105	Pot, 500 Ω	C2	C5	RP-97-500
R106	Resistor, 180k Ω , 5%, ¼W, Comp	G3	C2	R-76-180K
R107	Resistor, 47k Ω , 5%, ¼W, Comp	D4	C2	R-76-47K
R108	Resistor, 470k Ω , 5%, ¼W, Comp	E3	B2	R-76-470K
R109	Pot, 2k Ω	A3	B3	RP-104-2K
R110	Thick Film Resistor Network	Several	B4	TF-132
R111	Resistor, 10k Ω , 10%, 2W, Comp	B1	C5	R-3-10K
R112	Resistor, 22M Ω , 10%, ¼W, Comp	B1	B5	R-76-22M
R113	Resistor, 5.1k Ω , 5%, ¼W, Comp	E1	B2	R-76-5.1K
R114	Resistor, 1M Ω , 5%, ¼W, Comp	E1	B2	R-76-1M
R115	Resistor, Selected, 1%, ¼W, Mtf.	B2	B5	R-88-*
R116	Resistor, Selected; 1%, ¼W, Mtf.	B2	B5	R-88-*
R117	Thick Film Resistor Network	Several	B5	TF-122
R118	Resistor, 150k Ω , 5%, ¼W, Comp	C5	A5	R-76-150K
R119	Thick Film Resistor Network	Several	A5	TF-121
R120	Resistor, 10k Ω , 5%, ¼W, Comp	C2	A5	R-76-10K
R121	Resistor, 10k Ω , 5%, ¼W, Comp	C2	A5	R-76-10K
R122	Resistor, Selected, 5%, ¼W, Comp	A3	B5	R-76-*
R123	Resistor, 22M Ω , 10%, ¼W, Comp	B3		R-76-22M
R124	Resistor, 6.8K Ω , 5%, ¼W, Comp	B3		R-76-6.8K
S101	Switch, Rotary	Several	C2	SW-428
S102	Switch, Rotary	B1	C4	SW-430
S103	Switch, SPDT, ON-OFF	H4	A2	SW-417
U101	3½ Digit Single Chip A/D Converter	G4	B1	LSI-22
U102	Dual Synchronous Up Counter	F1	B4	IC-282
U103	Low Power JFET Input Op Amp	D3, D4	B4	IC-279
U104	Low Power JFET Input Op Amp	E5, H5	C3	IC-279
U105	COS/MOS Quad Bilateral Switch	Several	B2	IC-149
U106	CMOS Quad Exclusive OR Gate	Several	B3	IC-226
U107	Dual "D" Type Flip-Flop	B6	B3	IC-103
U108	14-Stage Binary Counter	B5	B4	IC-280
U109	Linear Op Amp	B2	B5	IC-203
U110	Current Source	A2	B5	IC-278
U111	Quad 2-Input NOR Gate	Several	B2	IC-108
U112	COS/MOS Divide by "N" Counter	G2	B3	IC-145
U113	Quad, 2-Input, AND Gate	Several	B3	IC-138
U114	Analog Multiplexer	D4	B4	IC-277
Y101	Resonator, 360kHz	E2	B2	CR-14

*Value selected during calibration at factory.

Disassembly Instructions

Place the unit face down on a bench or other similar surface and remove the battery compartment cover. Remove and disconnect the battery. Remove the two #4-40 x 7/8 retaining screws.

Grasp the bottom cover at the input jack end and with a lifting and forward pushing motion (see drawing), carefully remove the bottom cover. While removing the cover, feed the battery connector through the access hole in bottom of the battery compartment.

The component side of the PC board is now exposed and the battery can be reconnected for troubleshooting. To read the display, some light downward pressure at the top end of the circuit board may be required in order to make contact through the conductive elastomer strip, between the circuit board and the LCD.

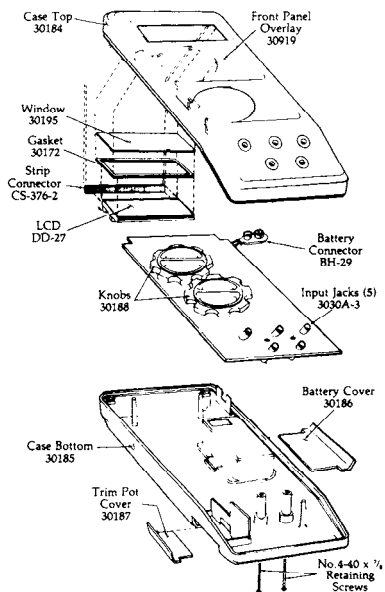

The PC board and LCD assembly are not secured once the case retaining screws are removed. Be careful not to allow the PC board and LCD assembly to fall out or shift out of position.

To remove the PC board from the top cover, grasp the TC switch assembly and lift until the input jacks become disengaged from the cover. The PC board can now be removed using a slight clockwise motion to free the two switch knobs from their normal positions in the case.

The LCD assembly will remain in the top cover when the PC board is removed. Again, be careful not to allow the LCD assembly to fall out accidentally.

The two switch knobs can be removed from the PC board assembly by simply pulling them off the switch shafts.

The LCD assembly, along with the strip connector, lifts out of the case.

To reassemble the Model 870 reverse the above procedure.

Note

Proper alignment of the strip connector is necessary when reinstalling the LCD assembly. Make sure that the conductor side of the strip connector is positioned against the plastic support of the LCD assembly.

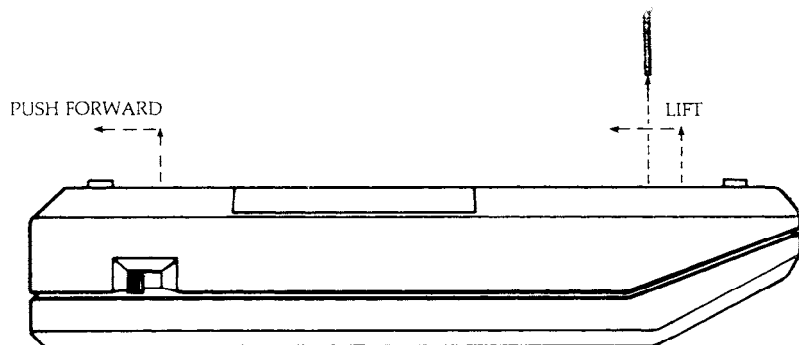

Operating Instructions

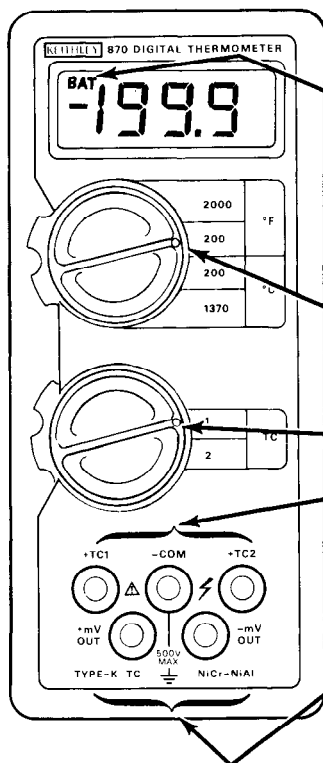

The 870 Digital Thermometer requires the use of K-type TC probes/sensors, such as the Model 8702 Thermocouple Sensor which is a supplied accessory.

Low Battery Indicator

Minus sign displayed; Plus sign implied



Overranged condition or open thermocouple.

1. SET POWER ON.
2. SELECT SCALE AND RANGE.
Fahrenheit — 200°F or 2000°F
Celsius — 200°C or 1370°C
3. SELECT THERMOCOUPLE — TC1 or TC2
4. INPUT JACKS.
+TC1 and -COM > Two separate inputs for temperature measurements.
+TC2
5. ANALOG OUTPUT JACKS.
+mV OUT and -mV OUT — Use a recorder to monitor temperatures or a sensitive DMM to make high resolution readings. Utilize the NBS Thermocouple Calibration Tables for converting voltage readings into temperature readings.

870 Connector

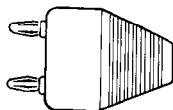

Probes/sensors terminated with the 870 connector plug directly into the 870. When this type of probe/sensor is connected to one channel input the other channel input becomes inaccessible. When this connector is first mated to the 870, a five-minute thermal stabilization period is recommended. This is because the banana style input connectors are made of materials different from the probe wires. It is strongly recommended that standard type dual banana plugs not be used. The large mass of these connectors could cause input thermal gradients resulting in measurement error.

WARNING

A shock hazard exists on the 870 input terminals when probes or sensors are exposed to voltage levels greater than 30V rms or 42.4V peak (A.N.S.I.).

CAUTION

To avoid instrument damage do not apply more than 150V across the input terminals of the 870.

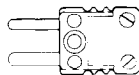

Miniature TC Plug

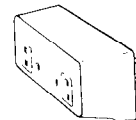

Model 8701 TC Adapter

The Optional Model 8701 TC Adapter is needed to utilize both input channels of the 870. The 8701 will accommodate one or two probes/sensors that are terminated with standard miniature TC plugs.

A 5-minute thermal stabilization period is recommended when the 8701 is first mated to the 870. No stabilization period is needed when mating the miniature TC plugs to 8701.

Accessories

MODEL 1304 SOFT CARRYING CASE AND STAND for the Model 870.

MODEL 8701 TC ADAPTER allows the user to make dual channel measurements and permits TC plug connection with either miniature or subminiature size plugs. Also, TC wires may be connected directly to screw terminals within the 8701 adapter.

MODEL 8711 THERMOCOUPLE KIT consists of a three foot TC wire sensor that has a beaded thermocouple junction and is terminated with a 870 connector. Also included in the kit is 20 feet of AWG No. 24 type-K duplex thermocouple wire, miniature TC plug/jack and standard TC plug/jack for making customized hookups.

Probes and Sensors

Six different types of probes/sensors are available from Keithley. They are terminated with either miniature TC plugs or 870 connectors. Probes/Sensors with 870 connectors (Models 870X) plug directly into the 870. Probes/Sensors with miniature TC plugs (Models 871X) require the optional Model 8701 TC Adapter and can be used in pairs.

MODEL 8702/8712 THERMOCOUPLE SENSOR consists of a three foot TC wire sensor that has a beaded thermocouple junction.

MODEL 8703/8713 IMMERSION PROBE — For liquid and general purpose applications up to 900°C.

MODEL 8704/8714 PENETRATION PROBE — For measurements within soft and semifrozen solids.

MODEL 8705/8715 SURFACE PROBE — Ball and socket construction keeps sensor tip flush to surfaces without critical positioning of probe.

MODEL 8706/8716 AIR/GAS PROBE — Exposed junction within protective shroud responds to ambient temperature while shielded from incident radiation.

MODEL 8707/8717 HYPODERMIC PROBE — Miniature junction responds with one-second time constant. All stainless steel construction is suitable for food industry, biological, and chemical applications.

SERVICE POLICY

For service on the Model 870 Digital Thermometer, contact your local representative who will be able to give you immediate assistance in most cases. Complete repair and calibration facilities are maintained in Cleveland, Ohio; Munich, West Germany; and Reading, United Kingdom, as well as first line repair service in Palaiseau, France. Information concerning the application, operation or service of your instrument may be directed to the applications engineer at any of the above locations.

WARRANTY

We warrant each of our products to be free from defects in material and workmanship. Our obligation under this warranty is to repair or replace, at our option, any instrument or part thereof which, within a year from date of shipment, proves defective upon examination. We will pay local domestic surface freight costs. (NOTE: This warranty does not cover battery replacement or damage due to battery leakage.)

KEITHLEY

Document No. 30925, Rev. A

Keithley Instruments, Inc./28775 Aurora Road/Cleveland, Ohio 44139/U.S.A./(216) 248-0400/Telex: 98-5469
WEST GERMANY: Keithley Instruments GmbH/Heighofstrasse 5/D-8000 München 70/(089) 714-40-65/Telex: 521 21 60
GREAT BRITAIN: Keithley Instruments, Ltd./1, Boulton Road/GB-Reading, Berkshire RG2 ONL/(0734) 86 12 87/Telex: 847047
FRANCE: Keithley Instruments SARL/2 Bis, Rue Léon Blum/B.P. 60/91121 Palaiseau Cedex/(6) 011.51.55/Telex: 600933F
NETHERLANDS: Keithley Instruments B.V./Leidselaanweg 149/Postbus 1190 /NL-Woerden/(03480) 13 643/Telex: 40 311
SWITZERLAND: Keithley Instruments SA/Filiale Dubendorf/Kriesbachstr. 4/CH-8600 Dubendorf/01 821 94 44/Telex: 57 536
AUSTRIA: Keithley Instruments Handels-Gesellschaft m.b.H./Doblinger Hauptstr. 32/A-1190 Wien/0222 314 289/Telex: 13 45 00